

Agilent IAM-92516 High Linearity GaAs FET Mixer

Data Sheet

Description

Agilent Technologies's IAM-92516 is a high linearity GaAs FET Mixer using 0.5 μm enhancement mode pHEMT technology. This device houses in Pb-free and Halogen free 16 pins LPCC 3x3^[2] plastic package. The IAM-92516 has built-in LO buffer amplifier which requires -3 dBm LO power to deliver an input third order intercept point of 27 dBm. LO port is 50 ohm matched and can be driven differential or single ended while IF port is 200 ohm matched and fully differential. RF port requires external matching network for optimum input return loss and IIP3 performance.

RF and LO frequency range coverage from 400 to 3500 MHz and IF coverage is from DC to 300 MHz. This mixer consumes 26 mA of current from a single 5V supply. Conversion loss is typically 6 dB and noise figure is typically 12.5 dB. Excellent output power at 1 dB compression of 9 dBm. LO to IF, LO to RF and RF to IF isolation are greater than 30 dB.

The IAM-92516 is ideally suited for frequency up/down conversion for base station radio card receiver and transmitter, microwave link transceiver, MMDS, modulation and demodulation for receiver and transmitter and general purpose resistive FET mixer, which require high linearity. All devices are 100% RF and DC tested.

Pin Connections and Package Marking

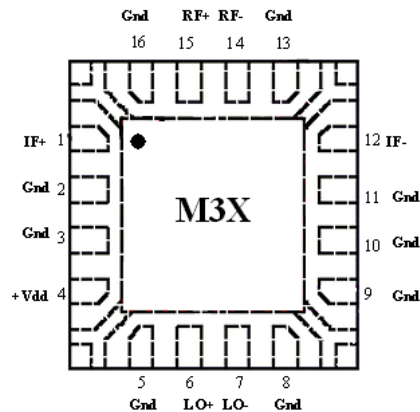

Notes:

Package marking provides orientation and identification

"M3" = Device Code

"X" = Month code indicates the month of manufacture



Attention:
Observe precautions for handling electrostatic sensitive devices.

ESD Machine Model (Class A)

ESD Human Body Model (Class 1A)

Refer to Agilent Application Note A004R:
Electrostatic Discharge Damage and Control.

Features

DC = 5V @ 26 mA (Typ.)
RF = 1.91 GHz, Pin_{RF} = -10 dBm;
LO = 1.7 GHz, Pin_{LO} = -3 dBm;
IF = 210 MHz unless otherwise specified

- Lead-free Option Available
- High Linearity: 27 dBm IIP3
- Conversion Loss: 6 dB typical
- Wide band operation: 400-3500 MHz RF & LO input DC – 300 MHz IF output
- Fully differential or single ended operation
- High P1dB: 9 dBm typical
- Low current consumption: 5V@ 26 mA typical
- Excellent uniformity in product specifications
- Small LPCC 3.0 x 3.0 x 0.75 mm package
- MTTF > 300 years^[1]
- MSL-1 and lead-free
- Tape-and-Reel packaging option available

Applications

- Frequency up/down converter for base station radio card, microwave link transceiver, and MMDS
- Modulation and demodulation for receiver and transmitter
- General purpose resistive FET mixer for other high linearity applications

Notes:

1. Refer to reliability datasheet for detailed MTTF data.
2. Conform to JEDEC reference outline MO229 for DRP-N



Agilent Technologies

IAM-92516 Absolute Maximum Ratings^[1]

Parameter	Units	Absolute Max.
Device Voltage	V	10
CW RF Input Power ^[2]	dBm	+30
CW LO Input Power ^[2]	dBm	20
Channel Temperature	°C	150
Storage Temperature	°C	-65 to 150

Thermal Resistance^[2,4]

$$\theta_{ch-c} = 47.6^{\circ}\text{C/W}$$

Notes:

1. Operation of this device above any one of these parameters may cause permanent damage.
2. Assuming DC quiescent conditions and $T_A = 25^{\circ}\text{C}$.
3. Board (package belly) temperature T_B is 25°C . Derate 21 mW/°C for $T_B > 85^{\circ}\text{C}$.
4. Channel-to-board thermal resistance measured using 150°C Liquid Crystal Measurement method.

Electrical Specifications

$T_A = 25^{\circ}\text{C}$, DC = 5V @ 26 mA, RF = 1.91 GHz, $\text{Pin}_{\text{RF}} = -10$ dBm; LO = 1.7 GHz, $\text{Pin}_{\text{LO}} = -3$ dBm, IF = 210 MHz unless otherwise specified.

Symbol	Parameter and Test Condition	Units	Min.	Typ.	Max.	Std Dev. ^[1]
F_{RF}	Frequency Range, RF	MHz	400		3500	
F_{LO}	Frequency Range, LO	MHz	400		3500	
F_{IF}	Frequency Range, IF	MHz	DC		300	
I_d	Device Current	mA	22	26	30	0.89
G_c ^[3]	Conversion Loss	dB		6	6.9	0.08
IIP3 ^[2]	Input Third Order Intercept Point	dBm	22	27		0.43
NF ^[3]	SSB Noise Figure	dB		12.5		
P1dB ^[3]	Output Power at 1 dB Compression	dBm		9		
RL_{RF}	RF Port Return Loss	dB		19		
RL_{LO}	LO Port Return Loss	dB		24		
RL_{IF}	IF Port Return Loss	dB		21		
$ISOL_{\text{L-R}}$	LO-RF Isolation	dB		34		
$ISOL_{\text{L-I}}$	LO-IF Isolation	dB		56		
$ISOL_{\text{R-L}}$	RF-IF Isolation	dB		33		

Notes:

1. Standard deviation number is based on measurement of at least 500 parts from three non-consecutive wafer lots during the initial characterization of this product and is intended to be used as an estimate for distribution of the typical specification.
2. IIP3 test condition: $F_{\text{RF1}} = 1.91$ GHz, $F_{\text{RF2}} = 1.89$ GHz with input power of -10 dBm per tone and LO power = -3 dBm at LO frequency $F_{\text{LO}} = 1.7$ GHz.
3. Conversion loss, P1dB and NF data have de-embedded balun loss = 0.8 dB @ 210 MHz.

Simplified Schematic

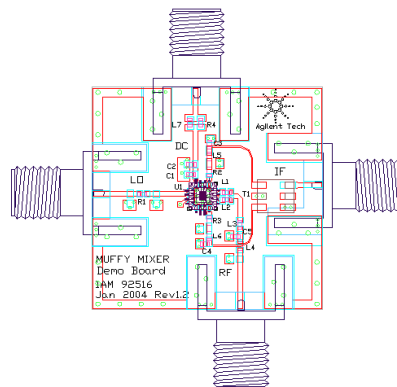
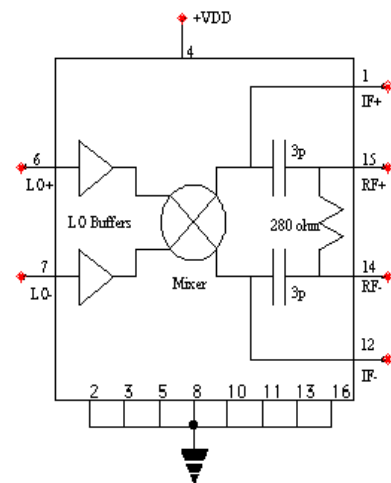

Figure 1. IAM-92516 Test Board.

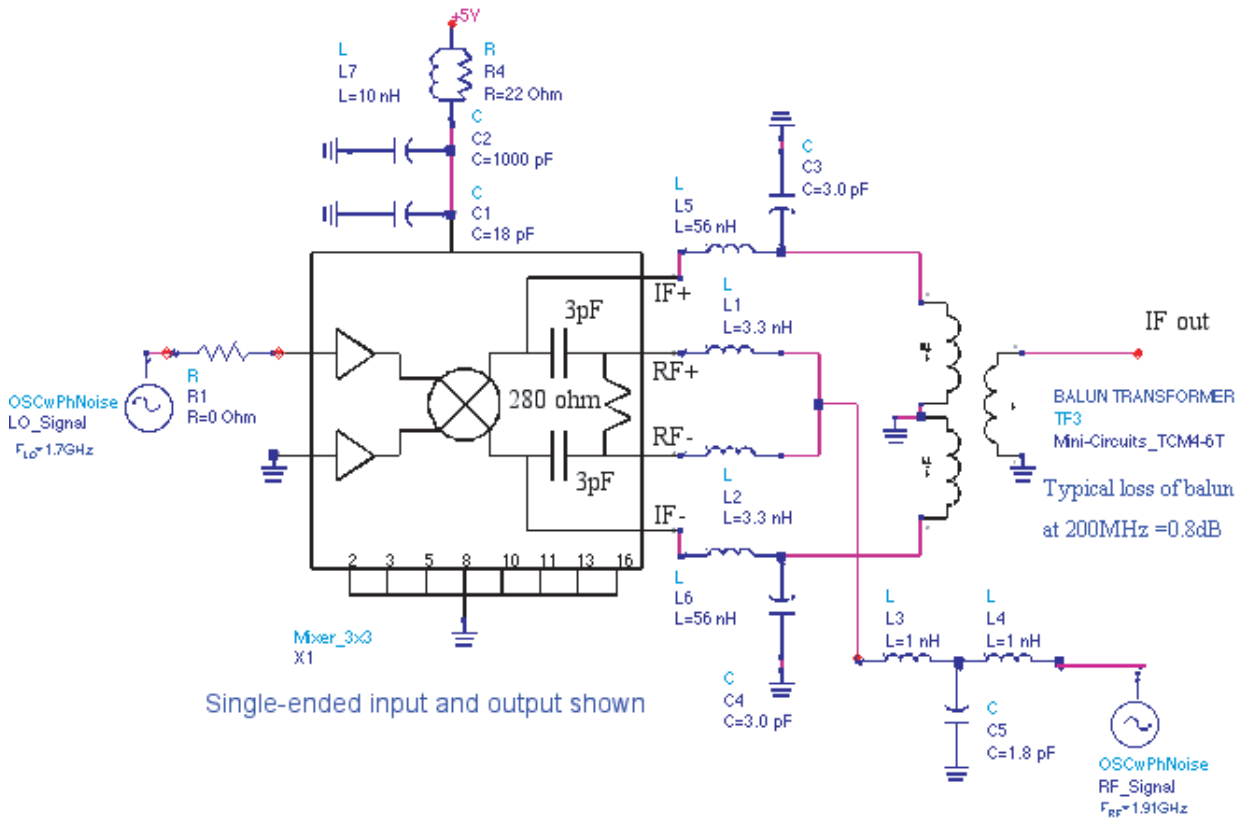

Figure 2. Schematic Diagram of IAM-92516 Test Circuit.

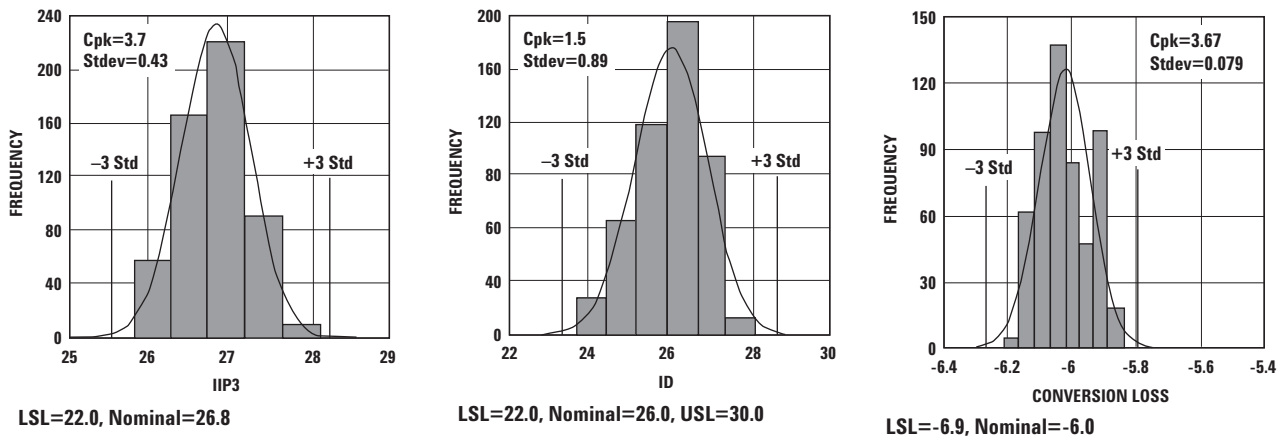

Figure 3. Normal Distribution of IIP3, ID, and Conversion Loss.

Notes:

- Distribution data sample size is 500 samples taken from 5 different wafers. Future wafers allocated to this product may have nominal values anywhere between the upper and lower limits.
- Conversion Loss data has de-embed balun loss 0.8 dB @ 210 MHz.

IAM-92516 Typical Performance

DC = 5V @ 26 mA, RF = 1.91 GHz, $P_{in_{RF}} = -10$ dBm; LO = 1.7 GHz, $P_{in_{LO}} = -3$ dBm, IF = 210 MHz unless otherwise specified

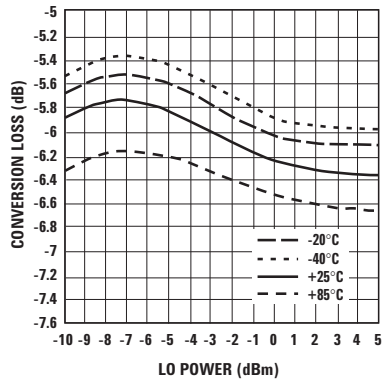

Figure 4. Conversion Loss vs LO Power Over Temperature.

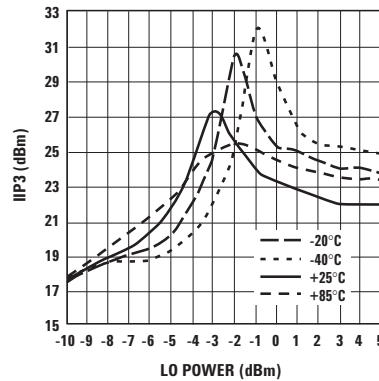

Figure 5. IIP3 vs LO Power Over Temperature.

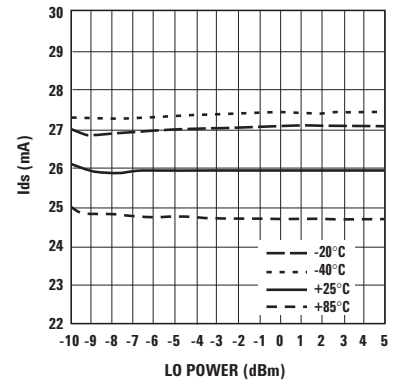

Figure 6. Ids vs LO Power Over Temperature.

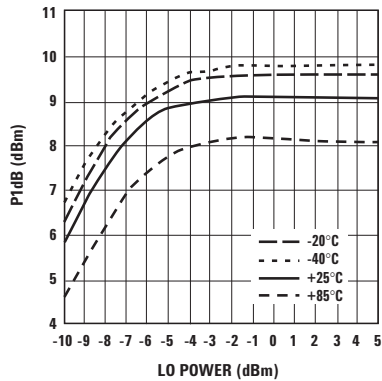

Figure 7. P1dB vs LO Power Over Temperature.

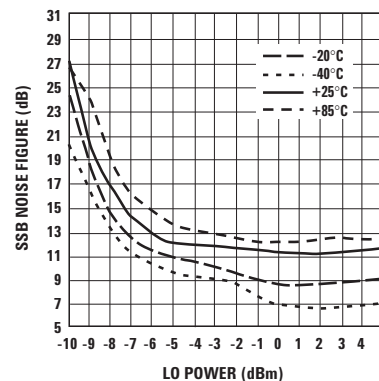

Figure 8. SSB NF vs LO Power Over Temperature.

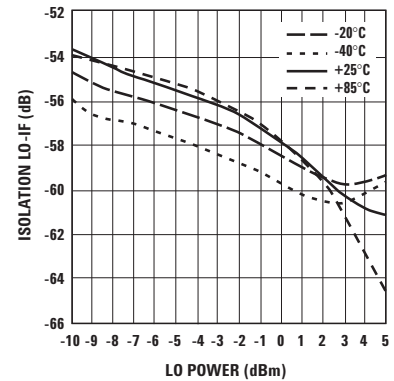

Figure 9. LO-IF Isolation vs LO Power Over Temperature.

Notes:

7. Typical performance plots are based on test board shown at Figure 1 with matching circuit stated at Figure 2.
8. Operating temperature range of Mini-circuit RF transformer (model: TCM4-6T) is -20°C to 85°C.
9. Conversion loss, P1dB and NF plots have de-embedded balun loss 0.8 dB @ 210 MHz.

IAM-92516 Typical Performance, continued

DC = 5V @ 26 mA, RF = 1.91 GHz, Pin_{RF} = -10 dBm; LO = 1.7 GHz, Pin_{LO} = -3 dBm, IF = 210 MHz unless otherwise specified

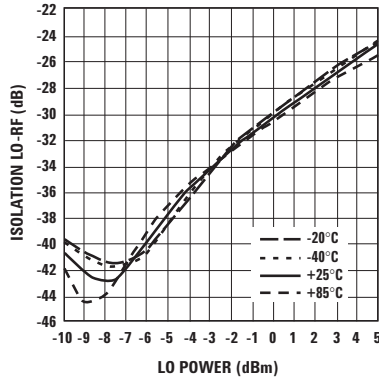

Figure 10. LO-RF Isolation vs LO Power Over Temperature.

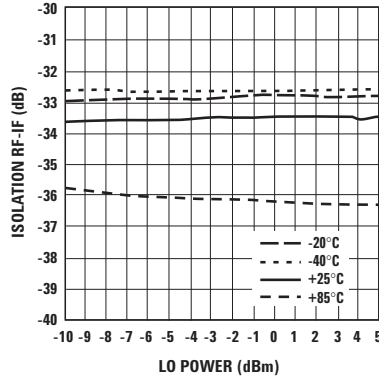

Figure 11. RF-IF Isolation vs LO Power Over Temperature.

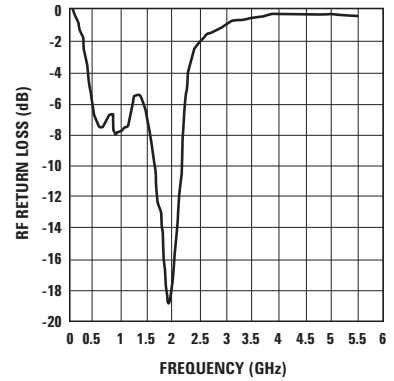

Figure 12. RF Return Loss vs Frequency.

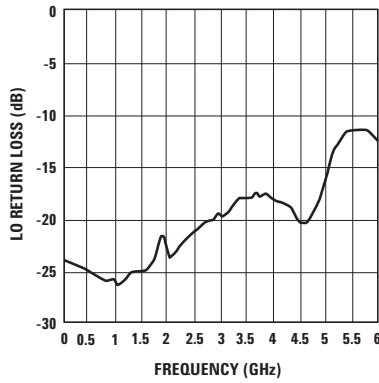

Figure 13. LO Return Loss vs Frequency.

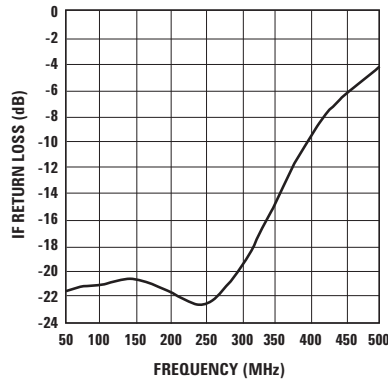

Figure 14. IF Return Loss vs Frequency.

RF Harmonics (mRF)	LO Harmonics (nLO)					
	0	1	2	3	4	5
0	—	0	18.5	12.9	11.6	5.8
1	19.5	0	51.3	60.6	42.8	55.2
2	39.9	67.3	56.6	78.3	64.7	87.2
3	51.2	>90	>90	>90	>90	>90
4	68.9	>90	>90	>90	>90	>90
5	>90	>90	>90	>90	>90	>90

Harmonic Intermodulation Suppression^[10]

Note:

10. Test Conditions of Harmonic Intermodulation Suppression:

- RF = 1.91 GHz @ -10 dBm and LO = 1.7 GHz @ -3 dBm.
- RF harmonics and intermodulation products are referenced to a desired signal produced by frequency IF = 210 MHz.
- LO Harmonics are referenced to the -3 dBm LO drive signal.

PCB Layout and Stencil Design

Refer to Agilent's web site
www.agilent.com/view/rf

Ordering Information

Part Number	Devices per Container	Container
IAM-92516-TR1	1000	7" reel
IAM-92516-TR2	5000	13" reel
IAM-92516-BLK	100	antistatic bag

LPCC 3x3 Package Dimensions

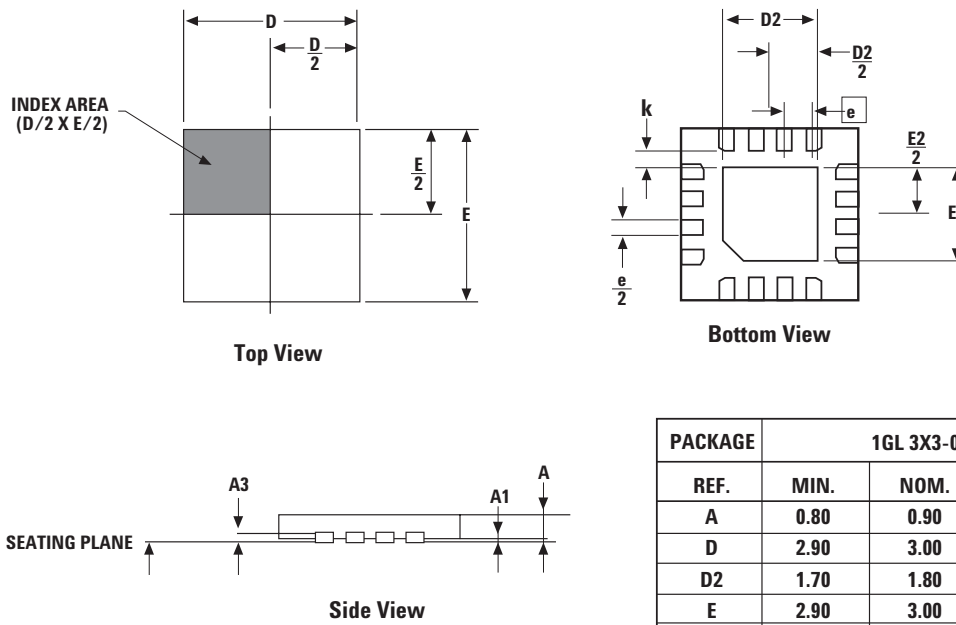

PACKAGE	1GL 3X3-0.50		
REF.	MIN.	NOM.	MAX.
A	0.80	0.90	1.00
D	2.90	3.00	3.10
D2	1.70	1.80	1.90
E	2.90	3.00	3.10
E2	1.70	1.80	1.90
e		0.50 BSC.	
A1	0	0.02	0.05
A3		0.20 REF.	
k	0.20		

DIMENSIONS ARE IN MILLIMETERS

Device Orientation

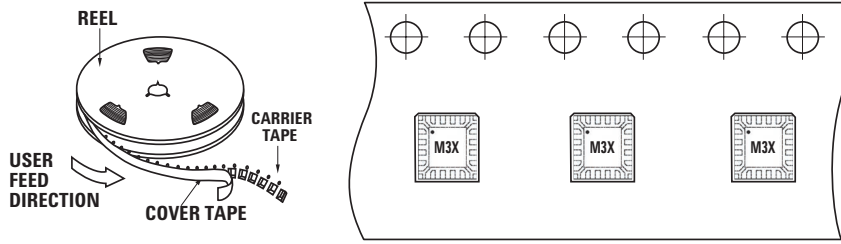

Tape Dimensions

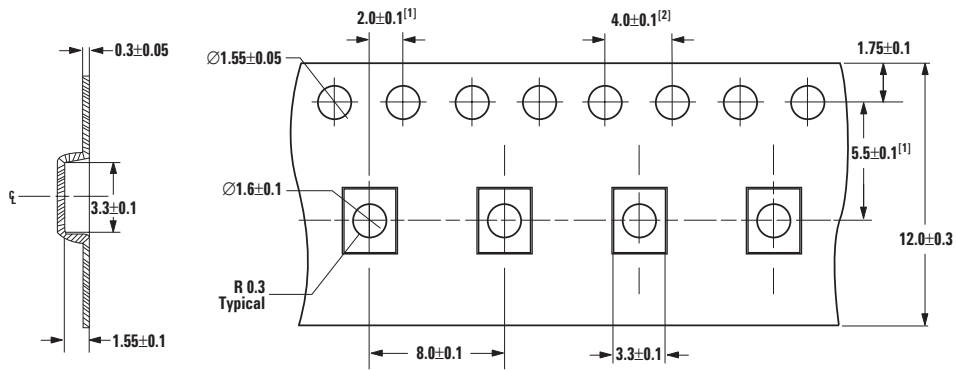

Notes:

1. Measured from centerline of sprocket hole to centerline of pocket
2. Cumulative tolerance of 10 sprocket holes is ± 0.20
3. Other material available
4. All dimensions in millimeter unless otherwise stated

www.agilent.com/semiconductors

For product information and a complete list of distributors, please go to our web site.

For technical assistance call:

Americas/Canada: +1 (800) 235-0312 or
(916) 788-6763

Europe: +49 (0) 6441 92460

China: 10800 650 0017

Hong Kong: (65) 6756 2394

India, Australia, New Zealand: (65) 6755 1939

Japan: (+81 3) 3335-8152(Domestic/International), or
0120-61-1280(Domestic Only)

Korea: (65) 6755 1989

Singapore, Malaysia, Vietnam, Thailand, Philippines,
Indonesia: (65) 6755 2044

Taiwan: (65) 6755 1843

Data subject to change.

Copyright © 2004 Agilent Technologies, Inc.

November 1, 2004

5989-0975EN



Agilent Technologies